

A Fuzzy Expert Model for Availability Evaluation

Dejan Ivezić, Miloš Tanasijević, Predrag Jovančić, Radiša Đurić



Дигитални репозиторијум Рударско-геолошког факултета Универзитета у Београду

[ДР РГФ]

A Fuzzy Expert Model for Availability Evaluation | Dejan Ivezić, Miloš Tanasijević, Predrag Jovančić, Radiša Đurić |
Proceedings of the 2019 20th International Carpathian Control Conference (ICCC) | 2019 | |

<http://dr.rgf.bg.ac.rs/s/repo/item/0005043>

Дигитални репозиторијум Рударско-геолошког факултета Универзитета у Београду омогућава приступ издањима Факултета и радовима запослених доступним у слободном приступу. - Претрага репозиторијума доступна је на www.dr.rgf.bg.ac.rs

The Digital repository of The University of Belgrade Faculty of Mining and Geology archives faculty publications available in open access, as well as the employees' publications. - The Repository is available at: www.dr.rgf.bg.ac.rs

A Fuzzy Expert Model for Availability Evaluation

Dejan Ivezic
Faculty of Mining and Geology
University of Belgrade
Belgrade, Serbia
dejan.ivezic@rgf.bg.ac.rs

Milos Tanasijevic
Faculty of Mining and Geology
University of Belgrade
Belgrade, Serbia
milos.tanasijevic@rgf.bg.ac.rs

Predrag Jovancic
Faculty of Mining and Geology
University of Belgrade
Belgrade, Serbia
predrag.jovancic@rgf.bg.ac.rs

Radisa Djuric
TPPs-OCMs Kostolac
Electric Power Industry of Serbia
Kostolac, Serbia
radisa.duric@te-ko.rs

Abstract—Each technical system within itself carries the great potential danger of possible occurrence of failure and damages. Mining machines are characteristic by great investment values, costs of unplanned shutdowns, complex working conditions, and environment and workers hazards. Systematic monitoring of the mining machinery is of great importance for the management of the mining companies. Availability is the overall concept of quality of service. Includes information regard to operating state, an idle state, a standby state and shut down. The availability can be calculated by the time coefficient, which includes mention time state. For time state tracking, specific IT structure is necessary. Such structure is often very expensive and unavailable.

An alternative is the expert system, which can absorb partial indicators of the availability, including their uncertainty, diversity, relativity. In this article, an expert's fuzzy model is presented to analyze and integrate reliability, maintainability, and functionality of three types of bulldozers that operate at the lignite mines. In the end, a comparison of the bulldozers is done. Conclusions can be used for maintenance, in logistics and during the purchasing of new machines.

Keywords—availability, expert system, fuzzy theory, bulldozers

I. INTRODUCTION

Availability is defined as the ability of the technical system to be able to perform the required function, under given conditions and at a given moment, or during a given interval of time, and assuming the necessary supply is provided (external resources). Availability may also be expressed as the probability that the system will be available at any calendar time, that is, it will be able to operate or to get involved. Availability should not be mixed with reliability that gives the probability that the system will work during a selected period of time [1].

Availability is a measure of the state of the system in terms of its efficiency to start operation and to obtain outputs in the required range. The required range is set as the function of the criteria, for a given time and in given surrounding conditions. Availability is determined depending on the function of reliability and maintainability. Availability can also be observed depending on planned breakdowns and delays.

The availability is commonly used as a measure of dependability. Availability is expressed by quantitative indicators, and these indicators are measures of dependability and quality of service. Availability performance has a decisive influence on the dependability and the quality of service due to the known fact that the machine must be

primarily available for operation in order to obtain performance.

The achievement of the satisfactory value of the machine's availability in the operation depends largely on the appropriate maintenance procedures, logistic support, and from the appropriate maintenance assets [2]. Analytic determination of availability function is possible but requires specific, quite complex IT system. Therefore, in this paper, an expert model, that integrates reliability, maintainability, and supportability in the measure of availability is proposed. This model is based on fuzzy sets theory and it is implemented to three types of bulldozers that operate at the lignite mines. Obtained results are used for the improvement of maintenance and logistics procedures and additionally, could be used as a support during the purchase of new machines.

II. AVAILABILITY EVALUATION

Availability is the probability that an item will be in an operable and committable state at the start of a mission when the mission is called for at a random time and is generally defined as uptime divided by total time (uptime plus downtime) [5,6]. However, this definition does not provide complete information about availability. The obtained result does not provide the availability structure. Delays caused by completing paperwork, waiting for manpower, tools, test equipment or waiting for spares have an influence on machine availability but mostly they are not noted. Therefore, for providing relevant information about the availability of machines a significant amount of additional data and information should be included in analyses and processed. These data and information are very heterogeneous and include descriptions of failures, maintenance procedures, logistics' issues, financial aspects, etc. Hence, if someone is really interested in operational availability, it must be noted that reliability, maintainability, supportability and the other constituent parts of availability are crucial and must be established and optimized for the economic success of selected machine or overall business systems [5].

The most usual consideration of the availability of machines or any other engineering system in a complex manner is by taking into consideration indicators of reliability, maintainability, and supportability [5]. In other words, to provide complete information about the availability of selected machine all these phenomena must be taken into consideration. In practice, these indicators can be determined by complex calculations and taking into consideration different and very often, not so reliable sources of

information. The other approach is to use the experience of machine operators and workers in maintenance and logistics processes. The second approach is simpler and faster, and if it is verified by measured values it can be accepted as quite reliable.

The implementation of the second approach has two main obstacles. The first is that the phenomena of maintainability and supportability (sometimes and reliability) are characterized by indefinitely, multiplicity, subjectivity, mutual overlap. On the other hand, the challenge is how to take into consideration operators' opinions and judgments, and how to get a relevant resultant. In literature, such problems are usually solved using fuzzy sets theory [3,7].

III. AVAILABILITY ASSESSMENT MODEL

Figure 1 shows the conceptual model of the expert system for availability (A) evaluation based on fuzzy interference of reliability (R), maintainability (M) and supportability (S) input data. Input data are introduced to a model based on experts' opinions.

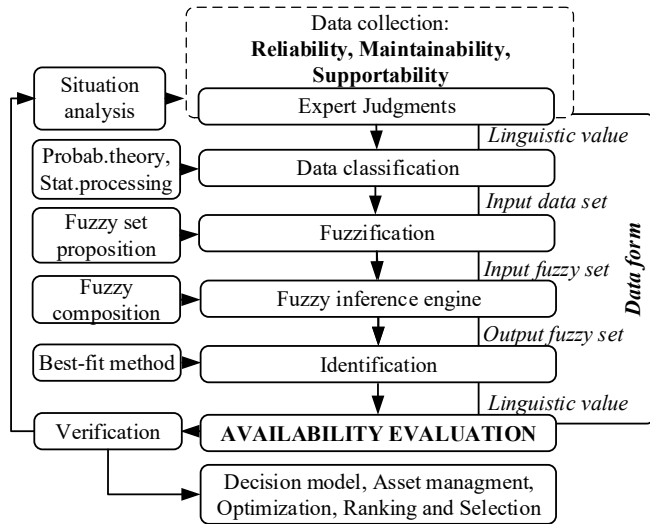

Fig. 1. The fuzzy model for availability evaluation

The mathematical and conceptual model of availability assessment is practically summarized in two steps: fuzzy proposition of availability partial indicators - R, M and S and fuzzy composition of mentioned indicators into one A.

The defining of linguistic variables for A, R, M and S is the first step in the creation of an expert model for A-assessment. This approach creates an environment for the fuzzy inference engine. Fuzzy sets are in triangular form and these are shown in figure 2, in relation to membership function (μ) and measurement units of A indicators ($j = 1 \dots n$). The fuzzy sets of R, M and S indicators have the same form. Values j can be an hour, a moto hour, etc., depending on the analyzed indicator. Regarding the number of linguistic variables, it can be found that seven is the maximal number of rationally recognizable expressions that human can simultaneously identify [8]. Therefore, the accepted value of linguistic variables is five (Fig. 2) for representing A and its indicators as fuzzy sets: poor, adequate, average, good and excellent.

For the introduction of operators' and experts' opinions and judgments in the availability assessment model, specific

questioners are created. For each indicator of A, operators/experts distributed 100% of their confidence to five fuzzy sets. Average value of confidences of all operators/experts to specific fuzzy set gives the value of appropriate membership function (μ).

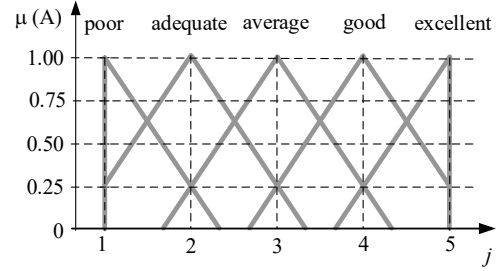

Figure 2. Availability fuzzy sets

In this way, the membership function of partial indicators of availability - R, M and S are determined as:

$$R = (\mu R_1, \dots, \mu R_j, \dots, \mu R_n);$$

$$M = (\mu M_1, \dots, \mu M_j, \dots, \mu M_n); \quad (1)$$

$$S = (\mu S_1, \dots, \mu S_j, \dots, \mu S_n);$$

Such membership functions could create $C = n^3$ mutual combinations. Each combination represents one possible input for synthesis and evaluation of A.

$$A_c = [\mu R^{j=1, \dots, n}, \mu M^{j=1, \dots, n}, \dots, \mu S^{j=1, \dots, n}],$$

$$\text{for all } c = 1 \text{ to } C \quad (2)$$

If only values of $\mu_{R,M,S}^{j=1, \dots, 5} \neq 0$ are taken into consideration, o outcomes ($o = 1$ to O , where $O \leq C$) are obtained.

Additionally, for each outcome, its value (Ω_c) is calculated. The outcome that suit the c^{th} combination is calculated following the equations:

$$\Omega_c = [\sum_{R,M,S}^j]_c / 3 \quad (3)$$

All of these outcomes are treated with the max-min composition, as follows:

- For each outcome search for the MINimum value of $\mu_{R,M,S}$ in vector A_c (2). The minimum that corresponds to the o -th combination is calculated following the equations:

$$\text{MIN}_o = \min\{\mu R^{j=1, \dots, 5}, \mu M^{j=1, \dots, 5}, \mu S^{j=1, \dots, 5}\},$$

$$\text{for all } o = 1 \text{ to } O \quad (4)$$

- Outcomes are grouped according to their values Ω_c , namely the size of j .

- Find the MAXimum between previously identified minimums for each group of outcomes. The maximum which corresponding the j^{th} value is calculated following the equations:

$$\text{MAX}_j = \max\{\text{MIN}_o\}, \text{ for every } j \quad (5)$$

The assessment of engineering system finally is obtained in the form:

$$A = (\text{MAX}_{j=1}, \dots, \text{MAX}_{j=5}) = (\mu A_1, \dots, \mu A_5) \quad (6)$$

The structure of the described max-min composition is presented in Fig. 3.

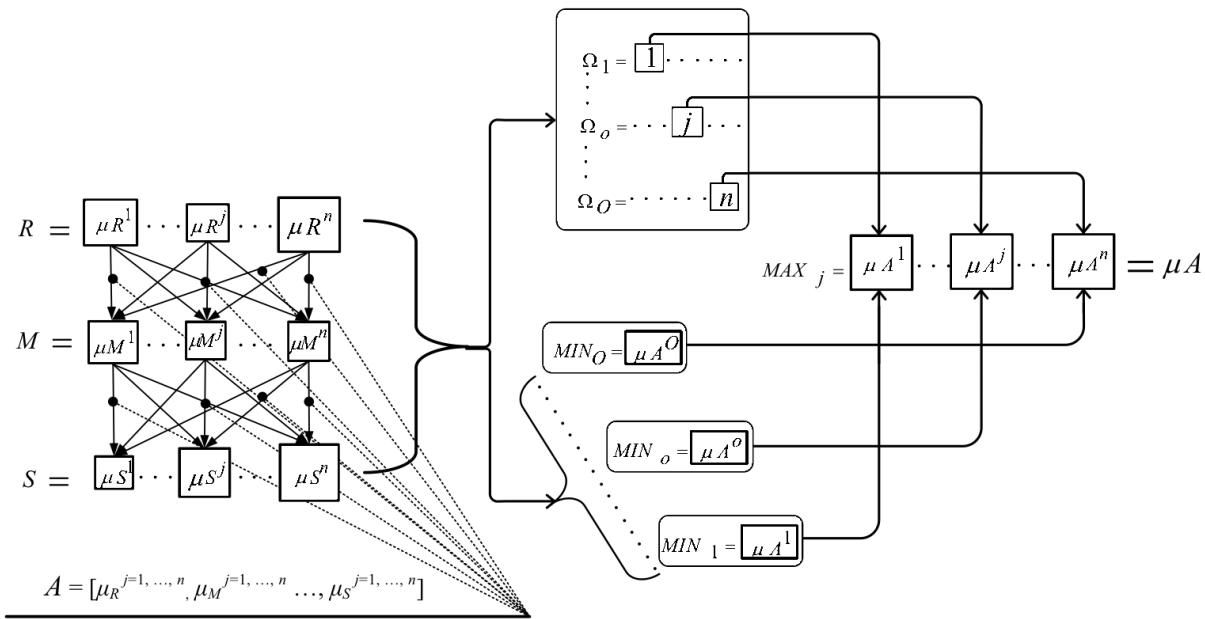

Figure 3. Structure of max-min composition (1)

IV. CASE STUDY: AVAILABILITY OF BULLDOZERS

Availability of bulldozers operating on surface lignite mines of Electric Power Industry of Serbia, which operate as auxiliary machines, is analyzed. Three different bulldozers (Liebherr - Lib, Dressta - Drs, Caterpillar - Cat), at three different surface mines (Drmno - D, Tamnava West Field - T, Field D - F) were considered. Availability evaluation was made based on experts' judgments and assessments. The fuzzy inference engine is used to synthesize mentioned fuzzy numbers (R, M and S) into one overall (A). Identification of obtained results, for their easier interpretation, is presented at the end, as well as their comparative analysis.

A. Proposition

The first step in the making of expert model for A assessment is describing linguistic variables related to A itself and to R, M and S. It is necessary to describe five linguistic variables i.e. fuzzy sets: poor, adequate, average, good and excellent. Fuzzy sets are in triangular form, and they are presented in relation to membership function (μ) and measurement units of A indicators ($j = 1 \dots 5$). Defined A fuzzy set can be written as:

- poor = $(1/j=1, 0.25/j=2, 0/j=3, 0/j=4, 0/j=5)$;
- adequate = $(0.25/j=1, 1/j=2, 0.25/j=3, 0/j=4, 0/j=5)$;
- average = $(0/j=1, 0.25/j=2, 1/j=3, 0.25/j=4, 0/j=5)$;
- good = $(0/j=1, 0/j=2, 0.25/j=3, 1/j=4, 0.25/j=5)$;
- excellent = $(0/j=1, 0/j=2, 0/j=3, 0.25/j=4, 1/j=5)$;

B. Questionnaire, statistical processing

Employees operating with the bulldozers or connected to their maintenance and logistic are asked to field in questionnaire. Questionnaire have multiple choices for evaluation (linguistic variables) of each indicator - R, M and S. Analysts evaluated affiliation to specific grade with 100%, or distributed their evaluation to several grades (given as linguistic variables) [4].

TABLE I. QUESTIONNAIRE FOR ASSESSMENT OF AVAILABILITY INDICATORS

Analyst No.	Availability indicator	Questionnaire: Bulldozer Liebherr – Drmno Open Pit Mine				
		Grade:				
		Excellent	Good	Average	Adequate	Poor
The degree of affiliation, %						
1	R		40	60		
	M			100		
	S				100	
2	R		20	80		
	M		100			
	S			50	50	
3	R		100			
	M			100		
	S			100		
4	R		80	20		
	M		80	20		
	S		100			
5	R	30	70			
	M		100			
	S		100			

Five analysts were interviewed at Drmno field - Kostolac basin (Table I). Analyst no.1 evaluated machine Liebherr in terms of R, with grades "good" in extent of 40% and "average" in extent of 60%; M as "average" in extent of 100% and S as "adequate" in extent of 100%; machine Dressta as "average" in all terms and Caterpillar as "good" in terms of R and S and "excellent" in term of M. This can be written in the form:

$$R(A1-Lib.) = 0.4/\text{good}, 0.6/\text{avr}; M(A1-Lib.) = 1/\text{avr}; S(A1-Lib.) = 1/\text{adeq};$$

$$R(A1-Drs.) = 1/\text{avr}; M(A1-Drs.) = 1/\text{avr}; S(A1-Drs.) = 1/\text{avr};$$

$$R(A1-Cat.) = 1/\text{good}; M(A1-Cat.) = 1/\text{exel}; S(A1-Cat.) = 1/\text{good};$$

Other grades for Drmno field – Kostolac basin are:

$R(A2-Lib.) = 0,2/good,0.8/avr$; $M(A2-Lib.) = 1/good$; $S(A2-Lib.) = 0,5/aver, 0.5/adeq$;

$R(A2-Drs.) = 0,2/good,0.8/avr$; $M(A2-Drs.) = 1/good$; $S(A2-Drs.) = 0,5/aver, 0.5/adeq$;

$R(A2-Cat.) = 0.8/exc,0.2/good$; $M(A2-Cat.) = 0.6/good,0.4/avr$; $S(A2-Cat.) = 0.5/good,0.5/avr$;

$R(A3-Lib.) = 1/good$; $M(A3-Lib.) = 1/avr$; $S(A3-Lib.) = 1/avr$;

$R(A3-Drs.) = 0,4/good,0.6/avr$; $M(A3-Drs.) = 1/adeq$; $S(A3-Drs.) = 1/adeq$;

$R(A3-Cat.) = 1/exc$; $M(A3-Cat.) = 1/good$; $S(A3-Cat.) = 1/good$;

$R(A4-Lib.) = 0.8/good,0.2/avr$; $M(A4-Lib.) = 0.8/good,0.2/avr$; $S(A4-Lib.) = 1/good$;

$R(A4-Drs.) = 0.8/good,0.2/avr$; $M(A4-Drs.) = 0.6/good,0.4/avr$; $S(A4-Drs.) = 0.5/aver,0.5/adeq$;

$R(A4-Cat.) = 0.6/good,0.4/avr$; $M(A4-Cat.) = 0.6/good,0.4/avr$; $S(A4-Cat.) = 0.7/exc,0.3/good$;

$R(A5-Lib.) = 0.3/exc,0.7/good$; $M(A5-Lib.) = 1/good$; $S(A5-Lib.) = 1/good$;

$R(A5-Drs.) = 0.5/good,0.5/avr$; $M(A5-Drs.) = 1/avr$; $S(A5-Drs.) = 0.8/aver,0.2/adeq$;

$R(A5-Cat.) = 0.8/good,0.2/avr$; $M(A5-Cat.) = 0.7/good,0.3/avr$; $S(A5-Cat.) = 1/good$;

Average grades for three types of bulldozers, which operate at Drmno basin, are:

$R(D-Lib.) = 0.06/exc,0.62/good,0.32/avr$; $M(D-Lib.) = 0.56/good,0.44/avr$; $S(D-Lib.) = 0.4/good,0.3/aver,0.3/adeq$;

$R(D-Drs.) = 0.34/good,0.56/aver,0.1/adeq$; $M(D-Drs.) = 0.12/good,0.68/aver,0.2/adeq$; $S(D-Drs.) = 0.56/aver,0.44/adeq$;

$R(D-Cat.) = 0.52/exc,0.4/good,0.08/avr$; $M(D-Cat.) = 0.4/exc,0.38/good,0.22/avr$; $S(D-Cat.) = 0.14/exc,0.76/good,0.1/avr$;

On the base of questionnaires for eight analysts for Tamnava west field – Kolubara basin and seven analysts from Field D – Kolubara basin, final grades for bulldozers are:

$R(T-Lib.) = 0.13/exc,0.5/good,0.38/avr$; $M(T-Lib.) = 0.03/good,0.85/aver,0.13/adeq$; $S(T-Lib.) = 0.34/good,0.41/aver,0.25/adeq$;

$R(T-Drs.) = 0.13/exc,0.53/good,0.35/avr$; $M(T-Drs.) = 0.88/aver,0.13/adeq$; $S(T-Drs.) = 0.28/good,0.48/aver,0.25/adeq$;

$R(T-Cat.) = 0.6/exc,0.4/good$; $M(T-Cat.) = 0.5/exc,0.5/good$; $S(T-Cat.) = 0.06/exc,0.69/good,0.25/avr$;

$R(F-Lib.) = 0.4/exc,0.6/good$; $M(F-Lib.) = 0.71/good,0.29/avr$; $S(F-Lib.) = 0.14/exc,0.18/good,0.68/avr$;

$R(F-Drs.) = 0.57/good,0.43$; $M(F-Drs.) = 0.29/exc,0.14/good,0.43/aver,0.14/adeq$; $S(F-Drs.) = 0.14/exc,0.29/good,0.43/aver,0.14/adeq$;

$R(F-Cat.) = 0.54/exc,0.46/good$; $M(F-Cat.) = 0.57/exc,0.43/good$; $S(F-Cat.) = 0.18/exc,0.68/good,0.14/avr$;

C. Fuzzification

In the next step, these assessments are mapped on A fuzzy set (2) in order to obtain assessment in the fuzzy form. The example for machine Liebherr-D is presented in detail. R in this case study determined as, where it is to linguistic variable "excellent" joined weight 0.06. Thereby, fuzzy set excellent is defined as (1): $R_{exc} = (1/0, 2/0, 3/0, 4/0.25, 5/1)$.

In this way the specific values of fuzzy set good for machine Liebherr – Drmno:

$R_{exc.0.06} = \{1/(0 \times 0.06), 2/(0 \times 0.06), 3/(0 \times 0.06), 4/(0.25 \times 0.06), 5/(1 \times 0.06)\}$.

The remaining four linguistic variables are treated in the same way.

$R_{exc.0.06} = (1/0, 2/0, 3/0, 4/0.015, 5/0.06)$
 $R_{good.0.62} = (1/0, 2/0, 3/0.155, 4/0.62, 5/0.155)$
 $R_{avr.0.32} = (1/0, 2/0.08, 3/0.32, 4/0.08, 5/0)$
 $R_{adq.0} = (1/0, 2/0, 3/0, 4/0, 5/0)$
 $R_{poor.0} = (1/0, 2/0, 3/0, 4/0, 5/0)$

After adding to each j, the fuzzy expression (membership function μ) for reliability of Liebherr which operate on mine Drmno, is obtained:

$\mu_{RLib-D} = \{(0), (0.08), (0.155+0.32), (0.015+0.62+0.008), (0.06+0.155)\} = (0, 0.08, 0.475, 0.715, 0.215)$

In the same way, based on the questionnaire results for the others indicators M and S, are obtained in the forms:

$\mu_{MLib-D} = (0, 0.11, 0.58, 0.67, 0.14)$;

$\mu_{SLib-D} = (0.075, 0.375, 0.475, 0.475, 0.1)$

D. Fuzzy inference

These fuzzificated assessments μ_{RLib-D} , μ_{MLib-D} and μ_{SLib-D} are necessary to synthesize into assessment of A, using max-min composition.

In this case it is possible to make $C = 5^3 = 125$ combinations, out of which the 80 outcomes. First outcome (3) would be for combination 2-2-1: $A_{2-2-1} = [0.08, 0.11, 0.075]$, where is $\Omega_{2-2-1} = (2+2+1)/3 = 2$ (rounded as integer).

Smallest value (4) among the membership functions of this outcome is $MIN_{2-2-1} = 0.075$. Additional nine outcomes can be separated for $\Omega = 2$, and MIN value can be determined for each of those.

Further on, maximal value (5) is identified among mentioned minimal values, $MAX(MIN_{\Omega=2}) = 0.11$. In the same way, other outcomes are calculated. All these outcomes can be grouped around sizes $\Omega = 2, 3, 4$ and 5. Finally, we get expression for membership function (1) of A of machine Liebherr-D in form:

$\mu_A(Lib-D) = (0, 0.11, 0.475, 0.475, 0.14)$

E. Final Exam and Identification

Best-fit method [1] and proposed A fuzzy set give the final availability assessment for the machine Liebherr-D:

$\delta_1(A(Lib-D), exc) = [\sum_{j=1}^5 (\mu_{A(Lib-D)}^j - \mu_{exc}^j)]^{0.5} = [(0-0)^2 + (0.11-0)^2 + (0.475-0)^2 + (0.475-0.25)^2 + (0.14-1)^2]^{0.5} = 1.014$

For other fuzzy sets:

$\delta_2(A(Lib-D), good) = 0.592$,

$$\delta_3(A(\text{Lib-D}), \text{avr}) = 0.605,$$

$$\delta_4(A(\text{Lib-D}), \text{adq}) = 1.073,$$

$$\delta_5(A(\text{Lib-D}), \text{poor}) = 1.221.$$

$$\alpha_1 = 1 / (\delta_1 / \delta_{\min}) = 1 / (1.014 / 0.592) = 0.584$$

$$\alpha_2 = 1, \alpha_3 = 0.979, \alpha_4 = 0.552, \alpha_5 = 0.485.$$

$$\beta_1 = \alpha_1 / \sum_{j=1}^5 \alpha_j = 0.584 / (0.584 + 1 + 0.979 + 0.552 + 0.485) = 0.162$$

$$\beta_2 = 0.278, \beta_3 = 0.272, \beta_4 = 0.153, \beta_5 = 0.135.$$

Finally, we get the assessment (6) of A of machine Lib-D, in form:

$$A(\text{Lib-D}) = (0,162 / \text{exc}, 0,278 / \text{good}, 0,272 / \text{avr}, 0,153 / \text{adq}, 0,135 / \text{poor})$$

In the same way, we get the assessments for other bulldozers and for other basins:

$$A(\text{Drs-D}) = (0,121 / \text{exc}, 0,160 / \text{good}, 0,417 / \text{avr}, 0,179 / \text{adq}, 0,124 / \text{poor})$$

$$A(\text{Cat-D}) = (0,253 / \text{exc}, 0,312 / \text{good}, 0,175 / \text{avr}, 0,132 / \text{adq}, 0,127 / \text{poor})$$

$$A(\text{Lib-T}) = (0,142 / \text{exc}, 0,220 / \text{good}, 0,322 / \text{avr}, 0,183 / \text{adq}, 0,134 / \text{poor})$$

$$A(\text{Drs-T}) = (0,134 / \text{exc}, 0,196 / \text{good}, 0,361 / \text{avr}, 0,180 / \text{adq}, 0,130 / \text{poor})$$

$$A(\text{Cat-T}) = (0,306 / \text{exc}, 0,306 / \text{good}, 0,143 / \text{avr}, 0,122 / \text{adq}, 0,122 / \text{poor})$$

$$A(\text{Lib-F}) = (0,148 / \text{exc}, 0,404 / \text{good}, 0,206 / \text{avr}, 0,126 / \text{adq}, 0,116 / \text{poor})$$

$$A(\text{Drs-F}) = (0,166 / \text{exc}, 0,242 / \text{good}, 0,284 / \text{avr}, 0,172 / \text{adq}, 0,137 / \text{poor})$$

$$A(\text{Cat-F}) = (0,334 / \text{exc}, 0,281 / \text{good}, 0,141 / \text{avr}, 0,122 / \text{adq}, 0,122 / \text{poor})$$

Graphical interpretation of obtained results is presented at Figure 4. Figure 4.a shows the availability level for each machine individually. The machine Cat-F provides the highest level of availability. The availability is evaluated as "excellent" in extent of 33%. The lowest level of availability has the Drs-D machine. The availability is evaluated as "poor" and "adequate" in extent of 30%.

Figure 4.b shows the mean value of availability for all three types of machines. It is noted that the Caterpillar is generally rated with "excellent" and "good". The Dressta is usually "average". Liebherr is "good" with a tendency towards the "average".

From figure 4.c, it is seen that the most common rate is "good" with a tendency towards "average".

Figure 4.d shows that machines with the highest availability operate on the Field D, while the lowest availability is recorded for the machines on the Tamnava field.

F. Verifications of results

For bulldozers that operate at Tamnava and Field D, recorded data about uptime (t_1) and downtime (t_2) are available. These data for 5 years are presented in Table 2, as

well as calculated values (as a quotient of uptime and total time in operations) of availability for three types of bulldozers - for each year and the average [9]. Obtained results coincides with the result obtained by the expert model. The bulldozer with the higher availability in Table II is the bulldozer evaluated mostly as "excellent" and "good", while the bulldozer with the lowest availability in Table 2 has mostly "average" grade.

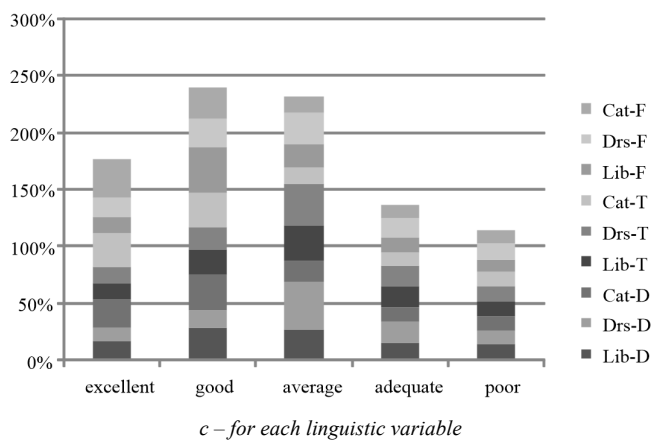
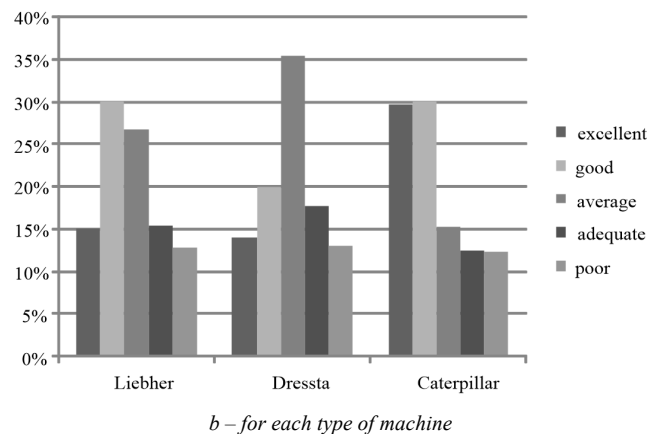
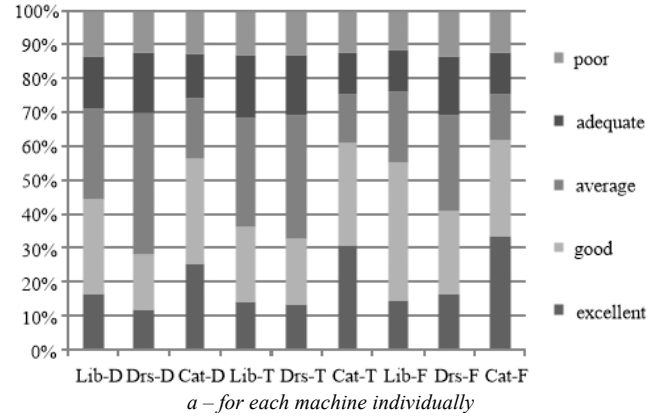

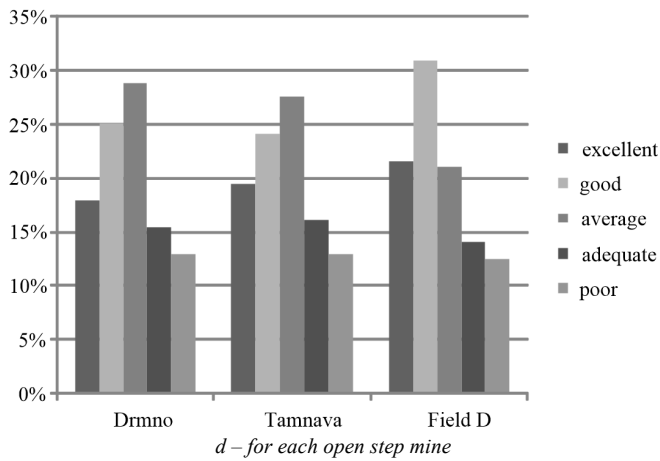

Fig. 4. Comparative analyze of obtaining results for bulldozers availability evaluation

TABLE II. DETERMINED AVAILABILITY ON THE BASE OF MEASURED TIME STATE PICTURE PARAMETERS

Liebherr			
Year	t_1 , [h]	t_2 , [h]	$A(t)$
I	3372	334	0,91
II	4100	498	0,89
III	4325	431	0,91
IV	3601	449	0,89
V	1438	234	0,86
0,89			
Caterpillar			
Year	t_1 , [h]	t_2 , [h]	$A(t)$
I	3415	262	0,93
II	3631	367	0,91
III	4296	494	0,90
IV	4127	445	0,90
V	2894	387	0,88
0,90			
Dressta			
Year	t_1 , [h]	t_2 , [h]	$A(t)$
I	3476	384	0,90
II	3102	572	0,84
III	2635	622	0,81
IV	2757	664	0,81
V	2008	343	0,85
0,84			

V. CONCLUSION

Bulldozers represent the most often utilized machinery on the surface mines. These machines are produced in large batches and it is very important to be selected in accordance with the working environment. Availability is an integral and important component of life cycle management for numerous engineering systems. This is quite a familiar term in engineering communication. This article described an expert's system for availability evaluation and model for availability calculation based to experts' opinions and judgments.

The availability for three different bulldozers that operate to three different open pit mines in Serbia was evaluated using the proposed expert model. Machines were compared individually (selected machine at selected open pit mine), but also integral comparisons between machines and open pit mines were made. Obtain results should be used for the improvement of maintenance and logistic support at open pit mines, as well as an important parameter during the further purchase of this type of machines.

Since the models based on experts' opinions in principle carry a dose of subjectivity, the presented model and obtained results are compared with calculated values of availability based on the measured parameters of bulldozers' operation. It was shown that experts' opinions correspond to measured values.

The main advantage of presented model is its simplicity and easy practical implementation. It does not request long term recording and monitoring necessary for determination of time state picture. The model could be used for preliminary evaluation and decision making concerning to asset management, optimization, ranking and selection, especially in the cases when reliable recorded data about machines' operation do not exist. Without any modification, the proposed model could be implemented to other engineering systems or products.

REFERENCES

- [1] Tanasijević M., Ivezić D., Jovančić P., Čatić D., Zlatanović D., Study of Dependability Evaluation for Multi-hierarchical Systems Based on Max-Min Composition, Quality and Reliability Engineering International, 29(3), 317-326, 2013.
- [2] Д.Я. Крунич, С. Вуйич, М. Танасиевич, Б. Димитриевич, Т. Шубаранович, С. Илич, С. Максимович. Модельные подходы к оценке жизненного цикла вспомогательных машин на примере угольного карьера в Сербии, Физико-технические проблемы разработки полезных ископаемых, 3, 51-61, 2018.
- [3] Erkoyncu J.A., Khan S., Eiroa A.L., Butler N., Rushton K, Brocklebank S., Perspectives on trading cost and availability for corrective maintenance at the equipment type level, Reliability Engineering & System Safety, 168, Pages 53-69, 2017.
- [4] NATO ARMP-4, Guidance for writing NATO r & m requirements documents (second ed.), ARMP-4, pp. 2-5, 1996.
- [5] Tanasijević M., A fuzzy-based decision support model for evaluation of mining machinery. Full Papers Proceeding of International Conference, 48th International October Conference on Mining and Metallurgy, Technical Faculty Bor, 15 - 18, Serbia, 28. Sep - 01. Oct, 2016.
- [6] G. Klir G.J., Yuan B., Fuzzy sets and fuzzy logic: theory and applications, Prentice-Hall, Inc. Upper Saddle River, NJ, USA
- [7] Kabir S., Papadopoulos Y., A review of applications of fuzzy sets to safety and reliability engineering, International Journal of Approximate Reasoning, Vol. 100, Pages 29-55, 2018.
- [8] Wang, J., Yang, J.B., Sen, P. Safety analyses and synthesis using fuzzy sets and evidential reasoning. Reliability Engineering and System Safety, 47(2), 103-118, 1995.
- [9] Ignjatovic, D., Jovancic, P., Optimization of operation and costs of auxiliary mechanization in order to increase the utilization of overburden and coal systems on the open cast mines of Public Enterprise "Elektroprivreda" Serbia – research study, Faculty of Mining and Geology, Belgrade, 2018 (in Serbian)